

CH-BR08-U40

[Chain BR08-U] Brass Standard Link Chandelier Chain

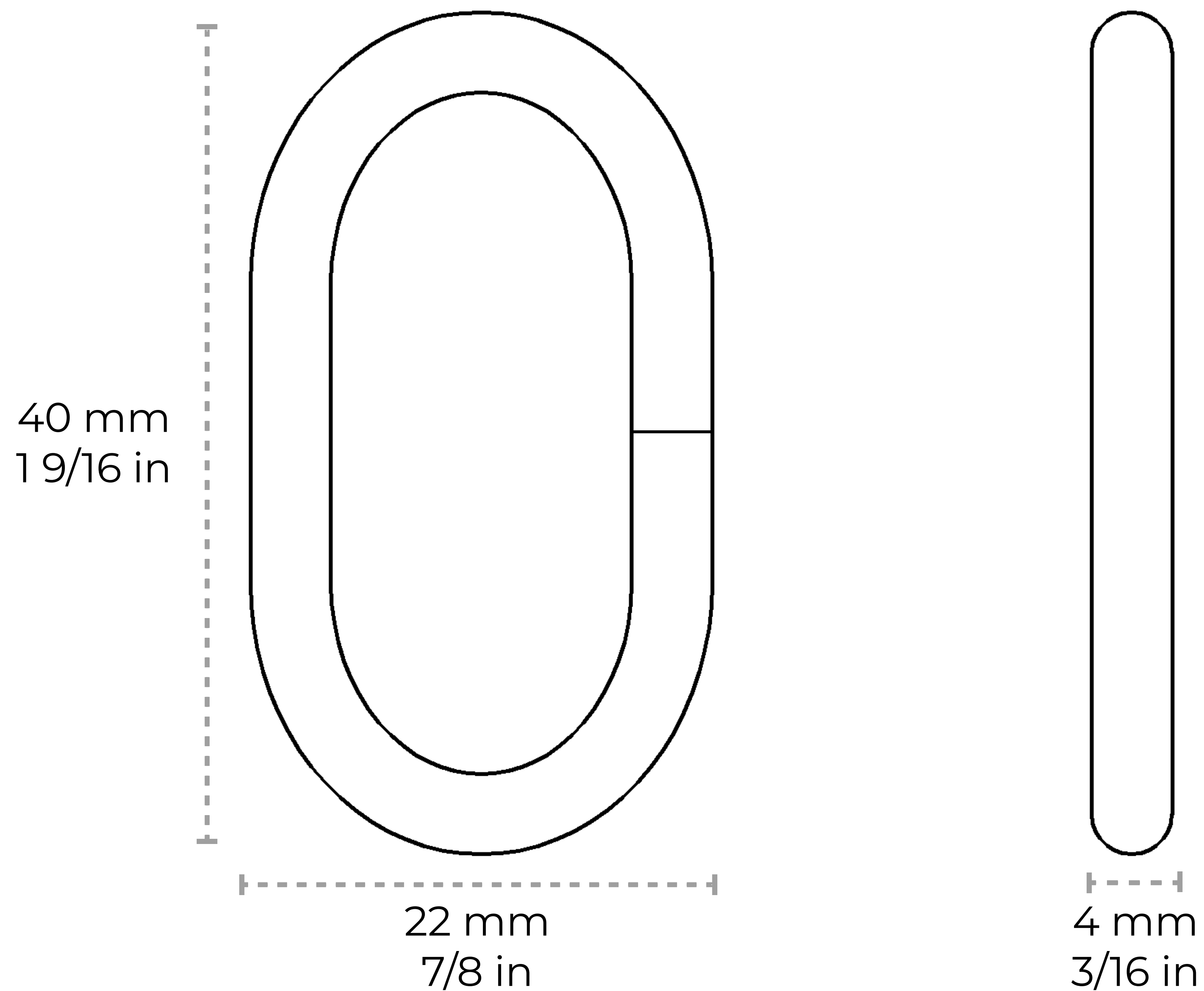

Material	Brass
Welding Type	Unwelded
Max Load	23 lbs
Weight per Foot	0.25 lbs/ft
Main Link Measurements	Length: 40 mm 1 9/16 in Width: 22 mm 7/8 in Diameter: 4 mm 3/16 in

Contact:

1-360-392-8121

<https://www.rchhardware.com>

