

QL-SS03-60

[Quick-Link SS03] Stainless Steel Quick Link

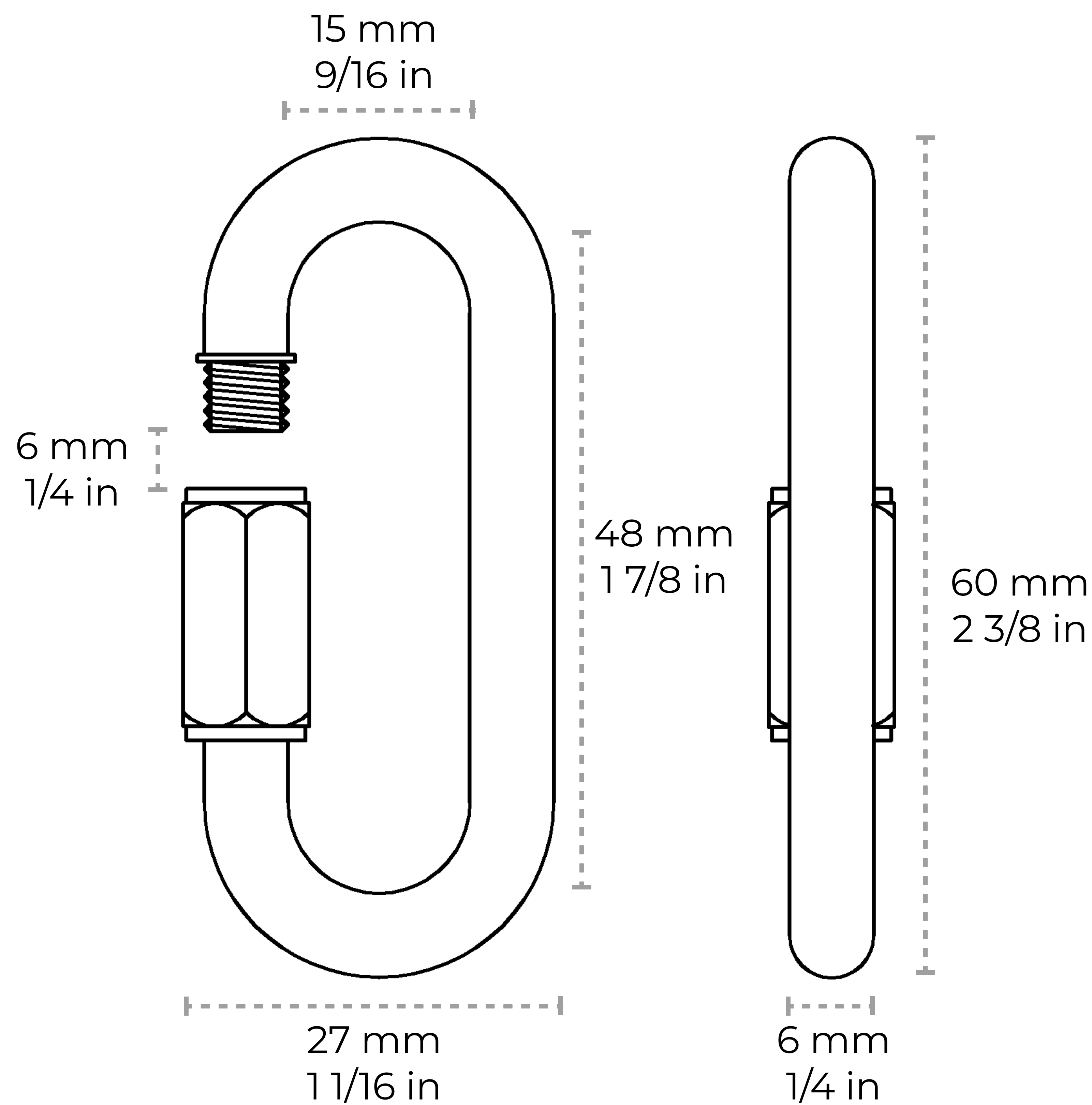

Material	Stainless Steel	
Weight	0.08 lbs	
Max Load	750 lbs	
Gauge	3	
Length	60 mm	2 3/8 in
Width	27 mm	1 1/16 in
Diameter	6 mm	1/4 in
Opening Length	6 mm	1/4 in
Inner Length	48 mm	1 7/8 in
Inner Width	15 mm	9/16 in

Contact:

1-360-392-8121

<https://www.rchhardware.com>

