

NO-IR530-50

[Number IR530] Iron Vintage Traditional House Number

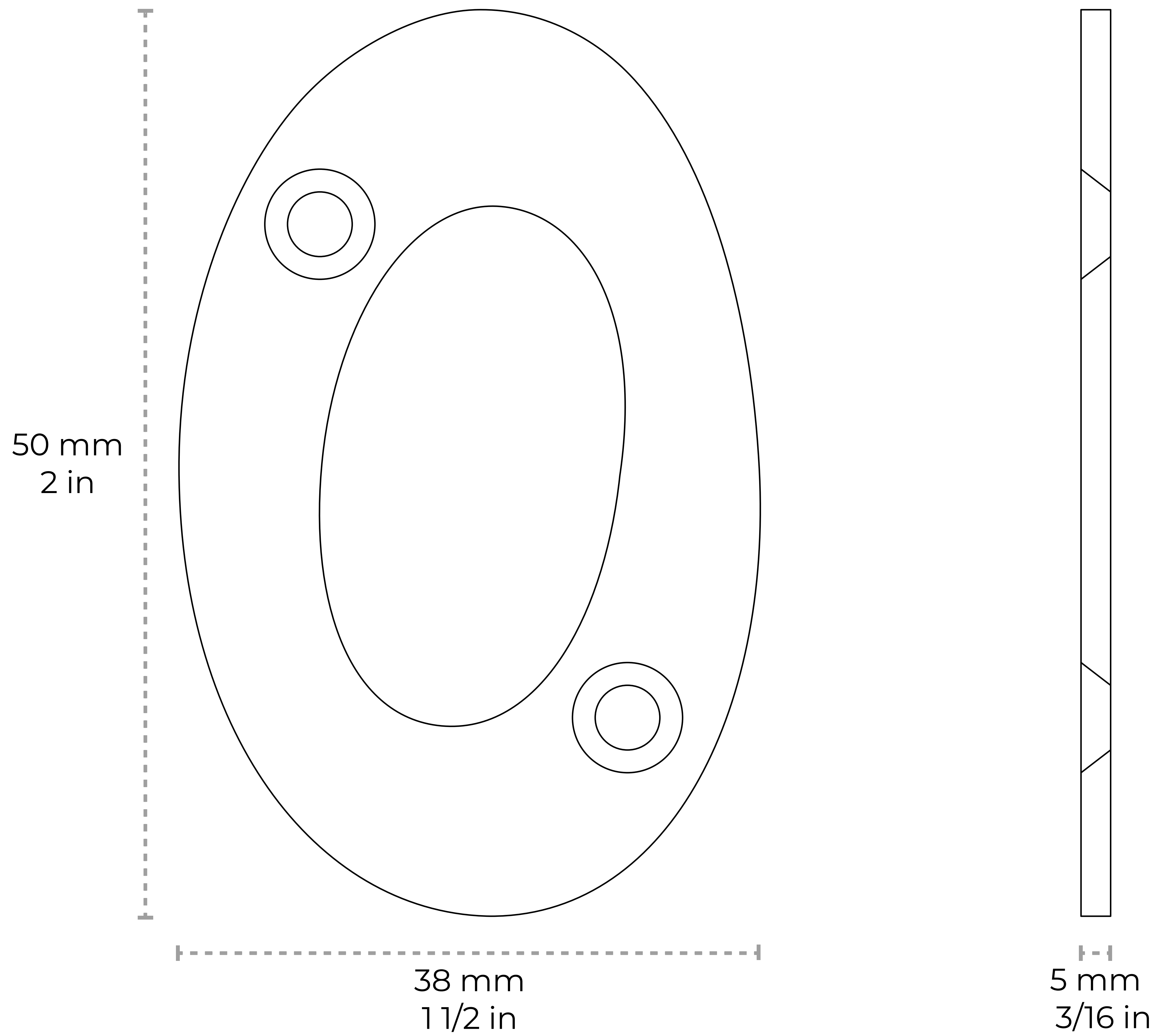

Material	Iron
Length	50 mm 2 in
Thickness	5 mm 3/16 in

Contact:

1-360-392-8121

<https://www.rchhardware.com>



Number	Weight (lbs)	Width (mm)	Width (in)
0	0.06	38	1 1/2
1	0.03	15	5/8
2	0.03	32	1 5/16
3	0.05	32	1 5/16
4	0.03	35	1 3/8
5	0.05	30	1 3/16
6	0.05	32	1 5/16
7	0.03	32	1 5/16
8	0.06	35	1 3/8
9	0.05	32	1 5/16